

LEM

by Francesco Beghetto

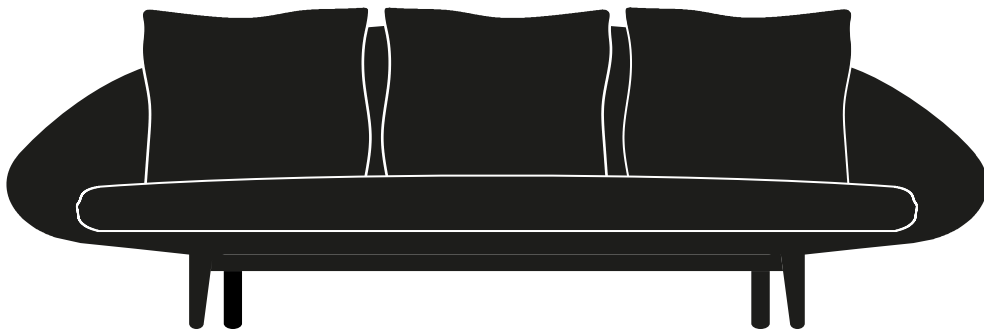

Lem è un divano morbido e sinuoso, con una struttura interamente rivestita in tessuto, che si slancia verso l'alto con dolci piedini. I morbidi cuscini della seduta e dello schienale si appoggiano sul guscio di tessuto garantendo il massimo comfort. La serie Lem è completa di cinque varianti, divano due e tre posti, divano componibile, poltroncina e ottomana.

Lem is a soft and sinuous sofa with a completely upholstered structure that ascends with sweet, little feet. The soft cushions of the seat and the back lean on the fabric shell, ensuring maximum comfort. The Lem series includes five variants, two or three seater sofa, sectional sofa, armchair, and ottoman.

DIMENSIONI | DIMENSIONS

lunghezza | width: 210 cm
larghezza | depth: 104 cm
altezza | height: 88 cm
altezza del sedile | seat height: 46 cm

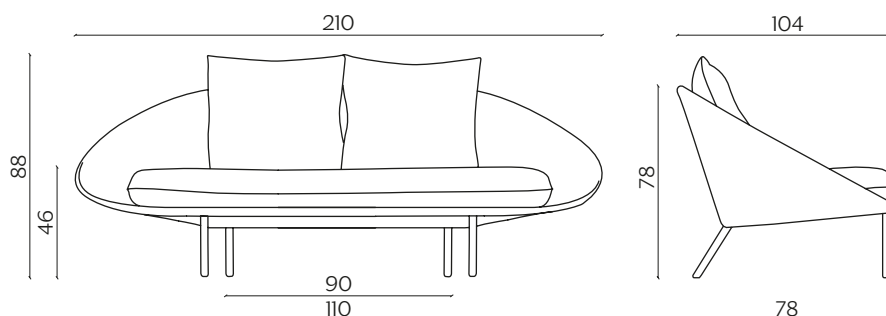

lunghezza | width: 267 cm
larghezza | depth: 104 cm
altezza | height: 88 cm
altezza del sedile | seat height: 46 cm

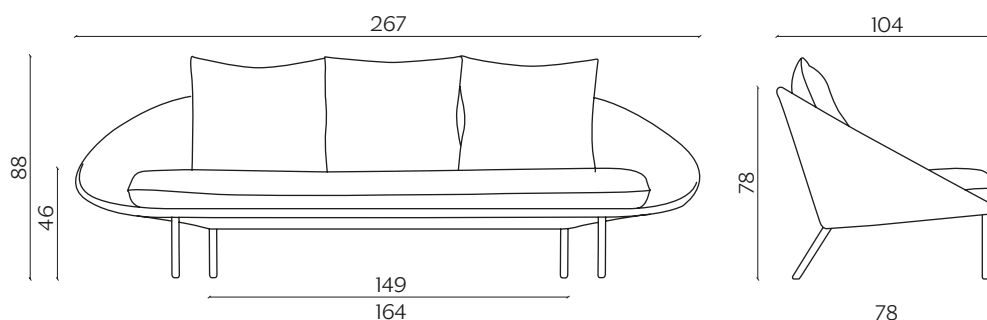

AMBIENTE | ENVIRONMENT

interno | indoor

DOWNLOAD | DOWNLOADS

la guida Cura e Manutenzione è disponibile su miniforms.com
Care and Maintenance guide is available at miniforms.com

file 2D, 3D e fotografie sono disponibili su miniforms.com
2D, 3D files and hi-res images are available at miniforms.com

FINITURE | FINISHES

STRUTTURA E CUSCINI | STRUCTURE AND CUSHIONS

Ecopelle | Ecoleather



Bianco
White



Avorio
Ivory



Grigio Scuro
Dark Grey



Nero
Black

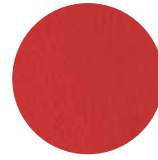

Rosso Scuro
Dark Red



Testa di Moro
Dark Brown



Tortora
Dove Gray

Tramè



Beige
Beige



Tortora
Dove Gray

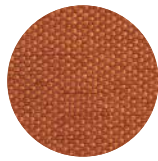

Arancio
Orange

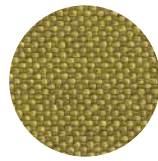

Pistacchio
Pistachio

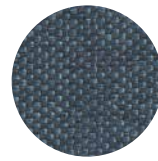

Blu Elettrico
Electric Blue

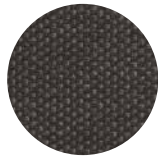

Antracite
Anthracite



Nero
Black

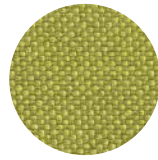

Mela
Apple

Shock

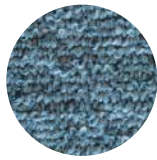

Oltremare
Ultramarine Blue



Nocciola
Nut Brown



Grigio Seta
Silk Grey

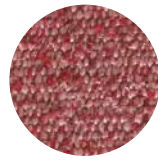

Corallo
Coral



Pietra
Stone Grey

Tanimo



Tortora
Dove Grey



Nocciola
Nut Brown



Mattone
Brick Red

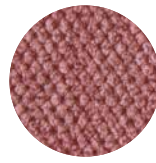

Millennial Pink
Millennial Pink

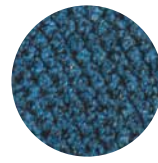

Oltremare
Ultramarine Blue

Loop

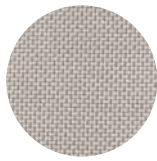

Tortora
Dove Grey

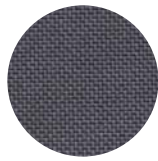

Grigio Piombo
Lead Gray

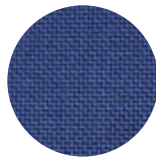

Blu Notte
Midnight Blue

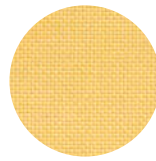

Giallo
Yellow

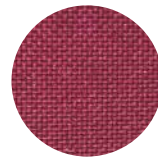

Rosso Bordeaux
Red Bordeaux



Rosso
Red

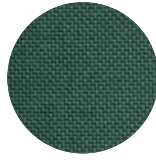

Verde
Green

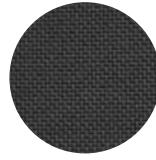

Nero
Black

Sponge



Grigio Chiaro
Light Grey

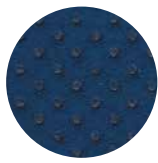

Blu
Blue

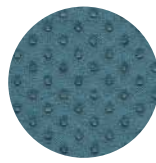

Azzurro
Light Blue

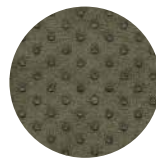

Verde
Green



Grigio Scuro
Dark Gray



Arancio
Orange



Beige
Beige



Giallo
Yellow

Twins

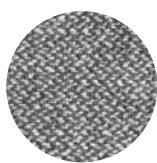

Cenere
Ash

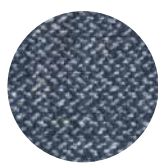

Oltremare
Ultramarine Blue

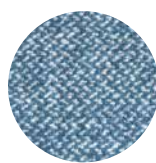

Jeans
Jeans



Polvere
Dust Gray



Tortora
Dove Grey

Etna

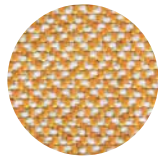

Miele
Honey

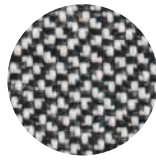

Sale e Pepe
Salt and Pepper

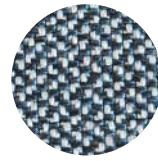

Blu Notte
Midnight Blue

Modi



Mandorla
Almond



Sale e Pepe
Salt and Pepper



Pietra
Stone Grey

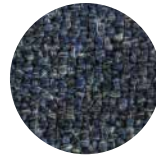

Blu Notte
Midnight Blue



Zafferano
Saffron Yellow



Ciliegia
Cherry

Millennial Visual

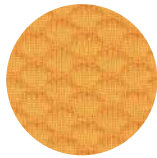

315



327

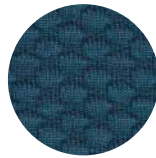

328

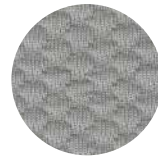

313

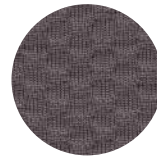

319

Econabuk



Nocciola
Light Brown



Marrone
Brown



Seppia
Sepia



Grigio
Grey



Antracite
Anthracite

Bubble



Nero
Black



Grigio
Grey

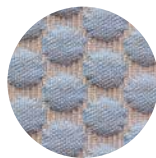

Azzurro
Light Blue

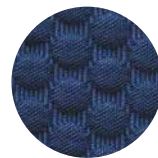

Blu Intenso
Intense Blue



Rosa
Pink

Regal Velvet

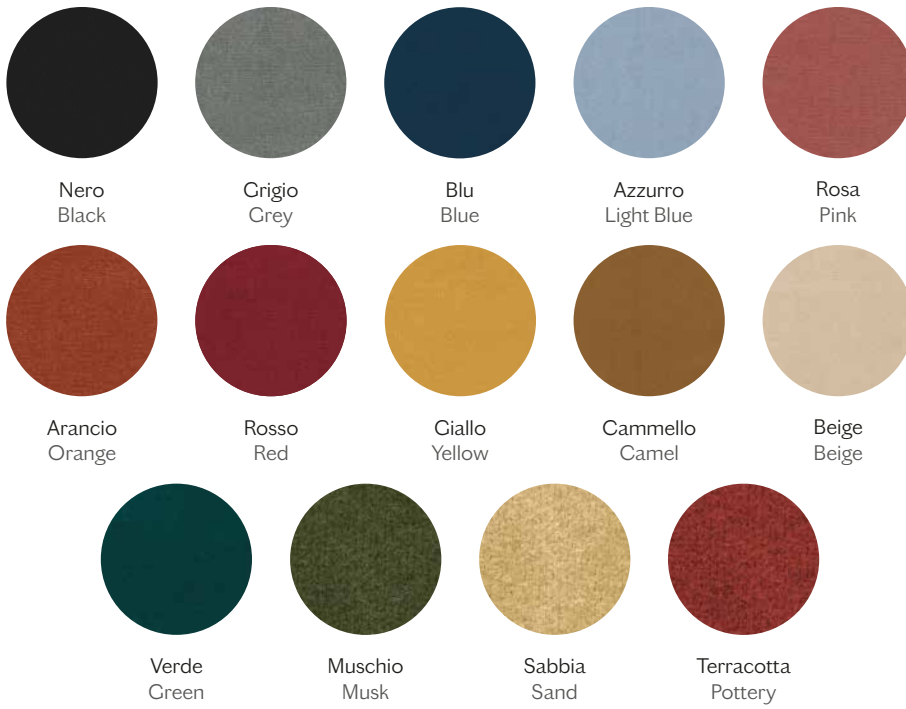

Barnum



Kvadrat - Maharam Merit

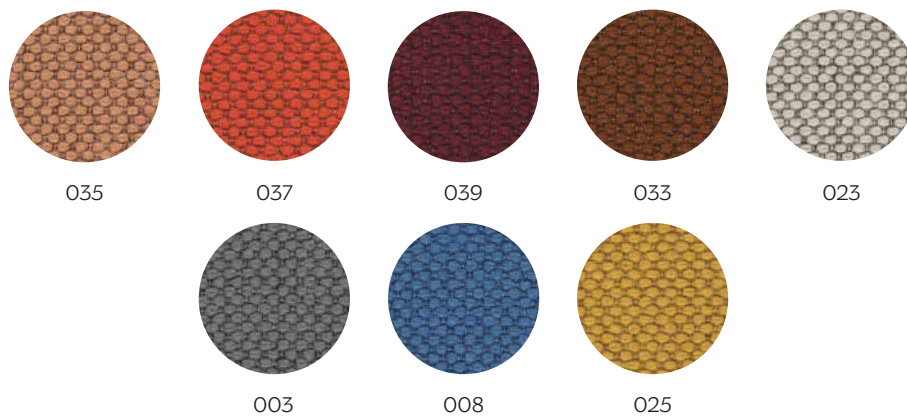

Kvadrat - Steelcut Trio 3

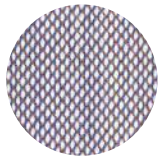

806

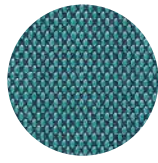

983



616

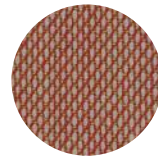

515

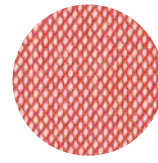

526

Esedra Tricot



4035-Borbogna
4035-Burgundy
Red



405-Sabbia
405-Sand



4018-Niagara
4018-Niagara
Blue